

Installation Instructions



1. Handpipes will arrive on site assembled, Ground Fixings will need to be installed **(1.1)** (See **Assembly Guide**)

2. Attach Ground Fixing posts to legs (See **Ground Fix Post Installation Sheet**)

3. **Excavate 2 holes** for the Steel legs **250mm diameter by 400mm deep** in desired location upon decision from customer.

4. Locate (lower) legs into holes making sure they are vertical and level prior to concreting in place.

5. Once happy with location of the Instrument, **fill** holes using rapid hardening **concrete**. Be sure to compact concrete around legs and leave to dry according to manufactures guidelines.

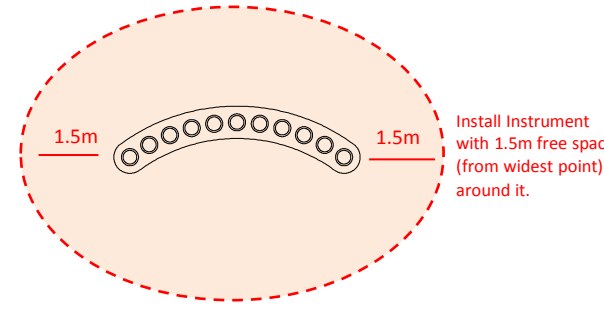

Ground Fixed

Handpipes
Page 1 of 3



Instrument Components:
Instrument assembled

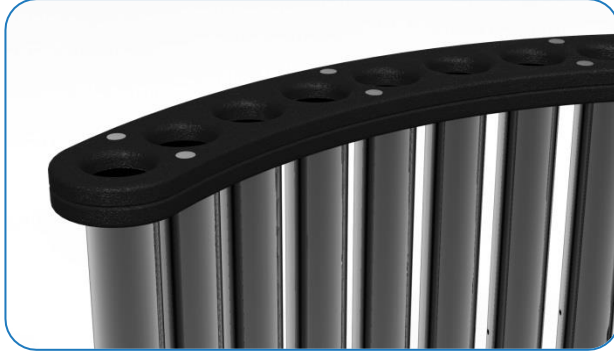

Weight of heaviest part **20kg** (Handpipes)

Metric Conversion:
250mm/ 10"
400mm/ 16"
905mm/ 35"
1.5m/ 59"

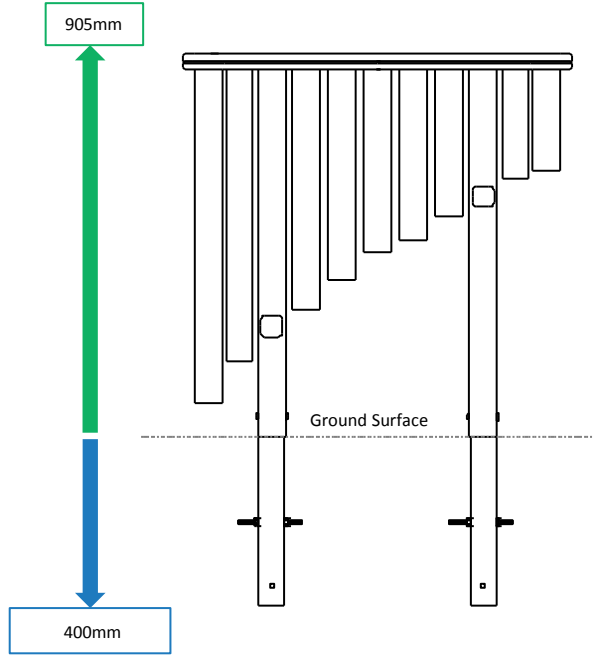

Ground Fix Components:

-  x4
M10x200 Bolt
-  x8
M10 Nut
-  x2
M10x60 Security Screw
-  x2
M10 Barrel Nut

Spares available form
percussionplay.com or from your
local distributor

25 Kg

Assembly Guide PPHAND

Ground Fixed

Handpipes
Page 2 of 3





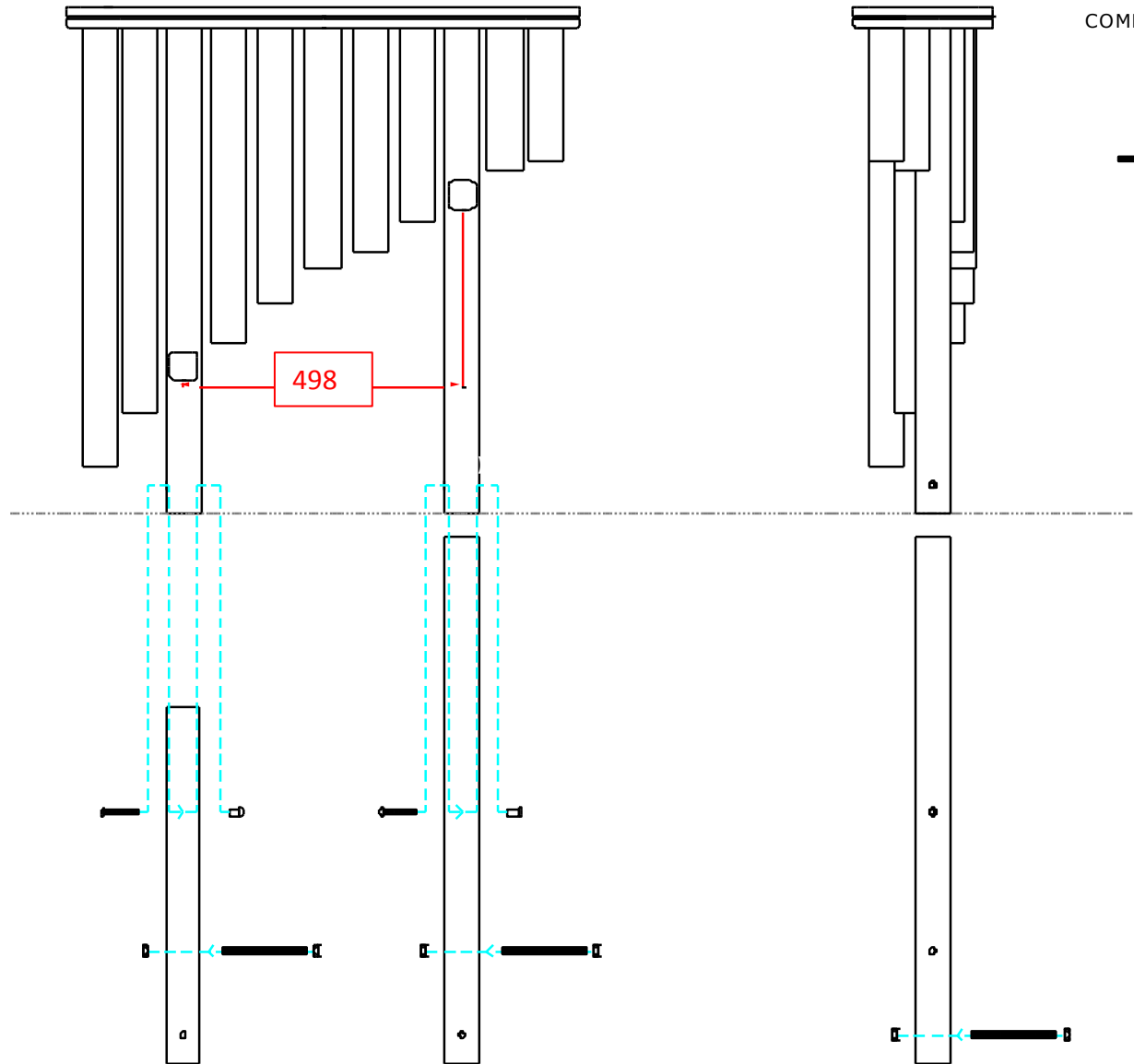

Instrument Components:

Instrument assembled



COMPONENTS LIST:

-  M10 Nut X8
-  M10x200 Th readed Bar X4
-  M10x60mm Security Screw X2
-  M10 Barrel Nut X2

Thread Lock Solution
Required (Not Supplied)



Ground Fix
Components:

-  x4
-  x8
-  x2
-  x2

Spares available from
percussionplay.com or from your
local distributor

25 Kg

Ground Fix Post Installation

Tools:



x2
TX 45 Driver Bit

Foundations should not present a hazard. These foundations are recommended as a guide, for more information on foundation details for various surface see Part 7 of BS EN 1176.

Ground Fixed

Handpipes
Page 3 of 3

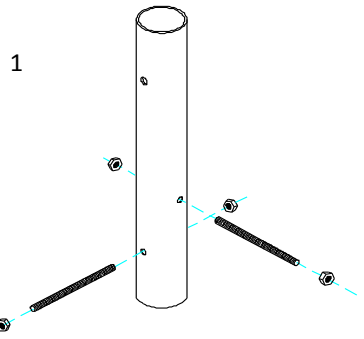

1 Insert M10x 200 Threaded bar into pre drilled holes in Ground Fixing Post

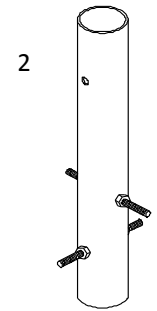

2 Fix M10x 200 Threaded bar in place using M10 Nuts

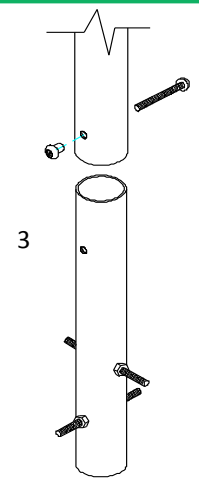

3 Locate the Ground fix Post into the leg of the instrument.

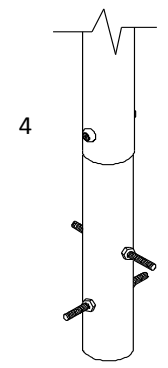

4 Fix instrument to Ground fix post using M10 bolt and Barrel Nut and use **thread locking solution** to prevent fixings working loose.

Components:

-  x4
-  M10x200 Bolt
-  x8
-  M10 Nut
-  x2
-  M10 Barrel Nut
-  x2
-  M10x60 Security Screw

Metric Conversion:
 50mm/ 2"
 250mm/ 10"
 350mm/ 14"
 400mm/ 16"
 450mm/ 18"

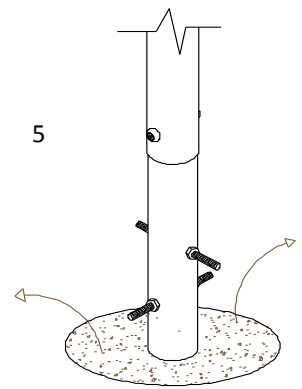

5 Excavate 6 holes with a 250mm diameter tapering down to 350mm diameter and 450mm depth

400mm min depth

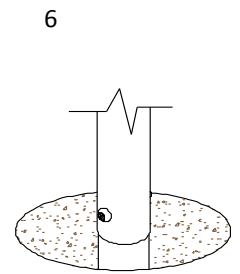

6 Compact base of hole with 50mm of aggregate. Lower ground Fix post attached to instrument into hole (check instrument straight and level before filling with concrete)

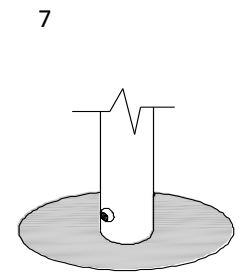

7 Fill hole with fast drying concrete to manufacturers specifications.

Repeat points 1-7. Handpipes requires 2 Ground Fix Posts

