

Installation Instructions

Ground Fixed

Marimba
Page 1 of 3



Instrument Components:

-  x4
- M10x50 Security Screw**
-  x4
- M8 Barrel Nut**
- 
- M8 Lock Nut X4**

Metric Conversion:
250mm/ 10"
400mm/ 16"
500mm/ 20"
650mm/ 26"
750mm/ 30"
1.5m/ 59"

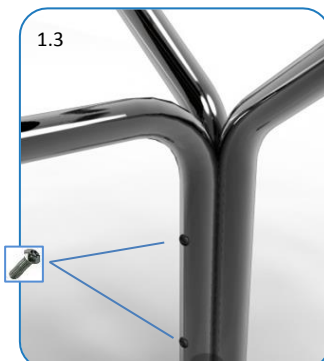
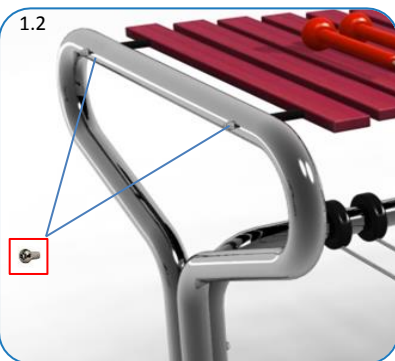

Weight of heaviest part **15kg** (Notes)

1. Assemble frame and notes as shown in images 1.2 and 1.3(see Assembly Guide)

2. Using M10 nuts and 150mm bolts supplied locate through pre drilled holes and secure bolts in place to support in ground pole in concrete. **3 bolts per leg at 120 degree angles. (1.4)**

3. Excavate 2 holes for the Marimba legs **250mm diameter by 400mm deep** in desired location upon decision from customer.

4. Locate (lower) legs into holes making sure they are vertical and level prior to concreting in place.

5. Once happy with location of the Marimba, fill holes using rapid hardening concrete. Be sure to compact concrete around legs and leave to dry according to manufactures guidelines.

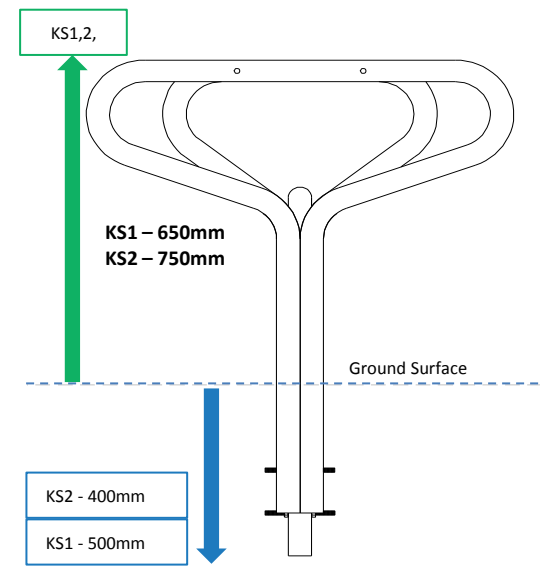
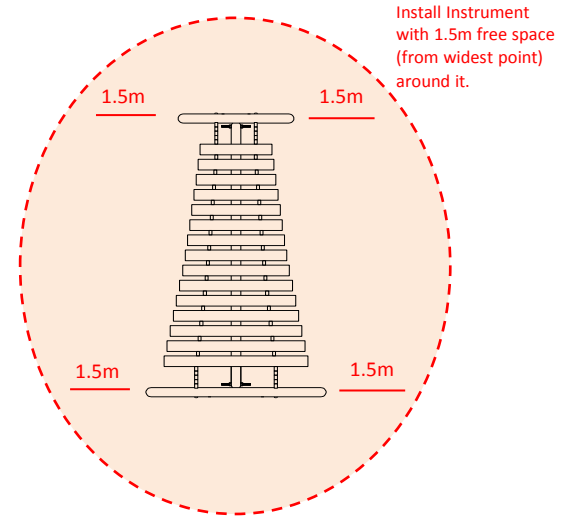



Ground Fix Components:

-  x4
- M10x200 Bolt**
-  x8
- M10 Nut**

Spares available form percussionplay.com or from your local distributor

42 Kg

Tools:

-  x1
-  x1
-  x1

Ground Fixed Marimba Page 2 of 3







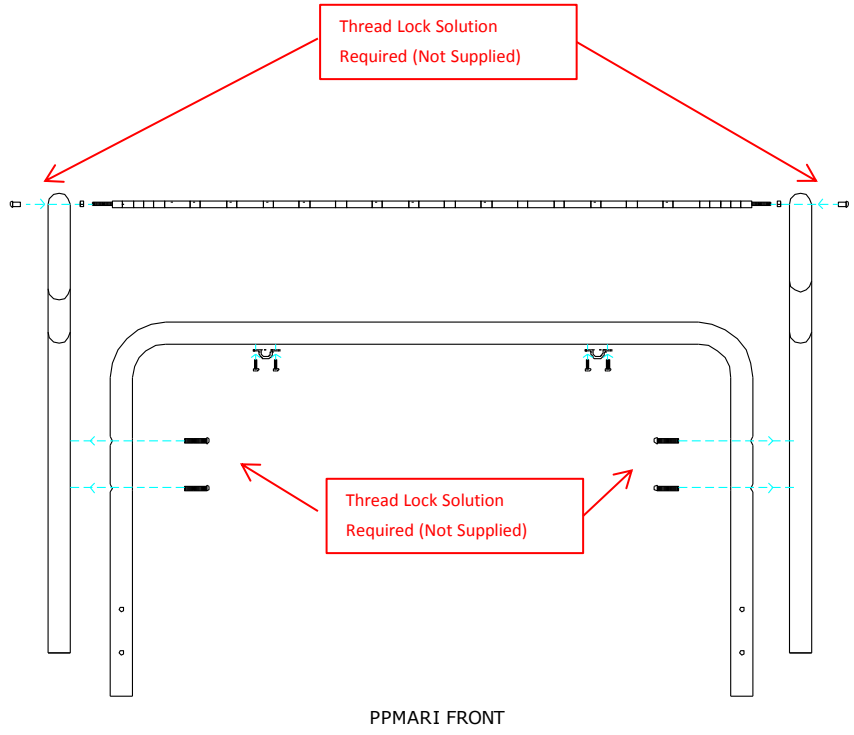
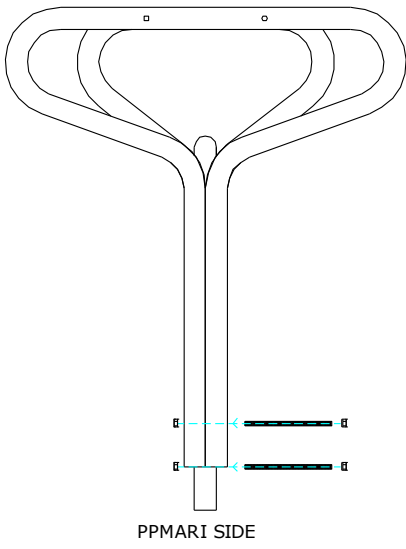

Instrument Components:

-  x4
M10x50 Security Screw
-  x4
M8 Barrel Nut
-  x4
M8 Lock Nut

Thread Lock Solution
Required (Not Supplied)



- COMPONENTS LIST:**
-  M10 Nut X8
 -  M10x150 Threaded Bar X4
 -  M10x50 Pin torx X4
 -  M8 Barrel Nut Pin torx X4
 -  M8 Nyloc nut X4
 -  Saddle Strap X1
 -  M6x20 Pin torx X2



Ground Fix Components:

-  x4
-  x8

Spares available from
percussionplay.com or from your
local distributor

42 Kg

Ground Fix Installation

Ground Fixed

Marimba
Page 3 of 3



1 Insert M10x 150 Threaded bar into pre drilled holes in Frame of Babel Drum using M10 BZP Nuts

2 Excavate 2 holes with a 250mm diameter tapering down to 350mm diameter and 450mm depth

3 Compact base of each hole with 50mm of aggregate. Lower ground the instrument into hole (check instrument straight and level before filling with concrete)

4 Fill hole with fast drying concrete to manufacturers specifications.

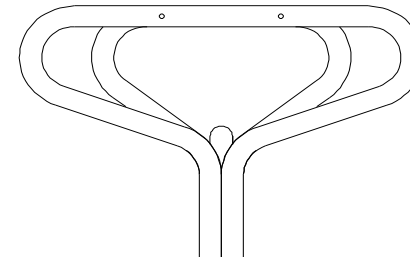
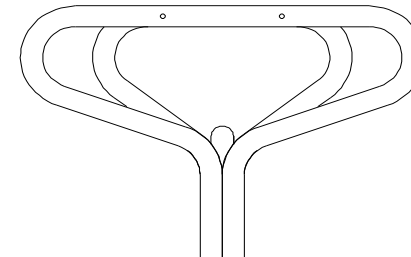
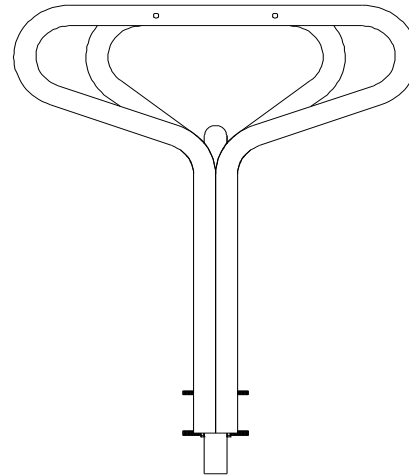
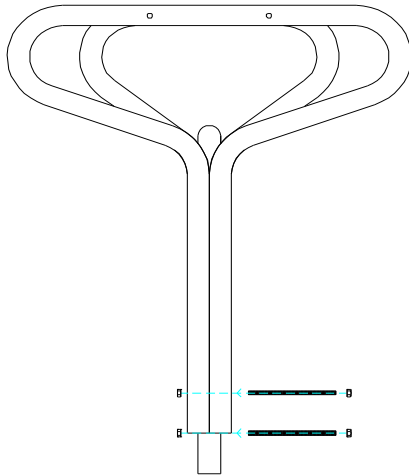

If Marimba needs to be positioned lower a deeper hole can be excavated.

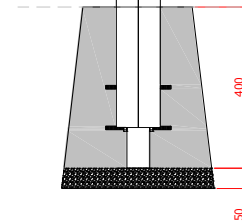
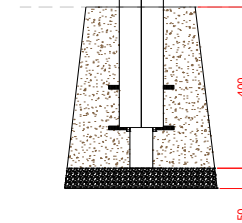
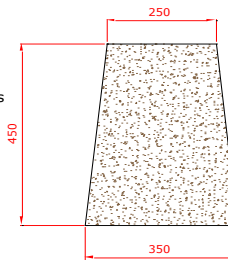

Components:



x4

M10x150 Threaded Bar



x8

M10 BZP Nut

Metric Conversion:

50mm/ 2"
250mm/ 10"
350mm/ 14"
400mm/ 16"
450mm/ 18"

Foundations should not present a hazard. These foundations are recommended as a guide, for more information on foundation details for various surface see Part 7 of BS EN 1176.