

Installation Instructions

Ground Fixed

Cattail (3)
Page 1 of 3

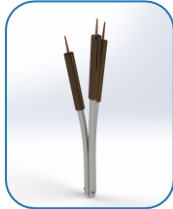

Components:



Metric Conversion:
400mm/ 16"
1651mm/ 65"

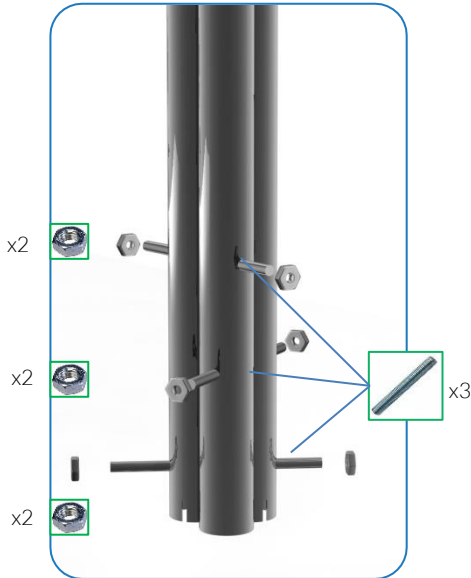

Weight of heaviest part **8Kg** (Large Bell)

1. Lay packaging out on floor and clear workspace with non-abrasive surface for assembly to prevent marking of polished stainless steel.

2. Unpack ground fixing extensions.

3. Cluster extensions together with M10 tapped holes facing outward and ground fixing holes aligned (**See Page 2**). Insert M10x200mm threaded bars into ground fixing holes and secure loosely with M10 nuts.

4. Unpack the Cattail chimes.

5. Sheath the shortest chime over one of the corner ground fix extensions and secure with an M10x20mm Security Screw.

6. Repeat clockwise in ascending order of post height.

7. Excavate a hole for the frame **250mm diameter, tapering down to 350mm, 450 deep** in desired location upon decision from customer.

8. Fill bottom 50mm of hole with compressed aggregate.

9. Locate (lower) frame into hole making sure that the stems are straight and upright. **Do not bury the bolt and barrel nut holes.**

10. Once happy with location of the instrument, **fill** hole using rapid hardening **concrete**. Be sure to compact concrete around legs and leave to dry according to manufactures guidelines.

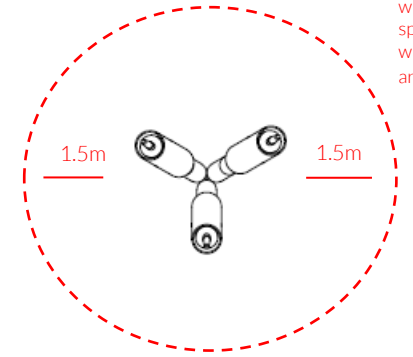

Install Instrument with 1.5m free space (from widest point) around it.

CAUTION: Frame surface can get hot in direct sunlight, if possible install in shaded areas.

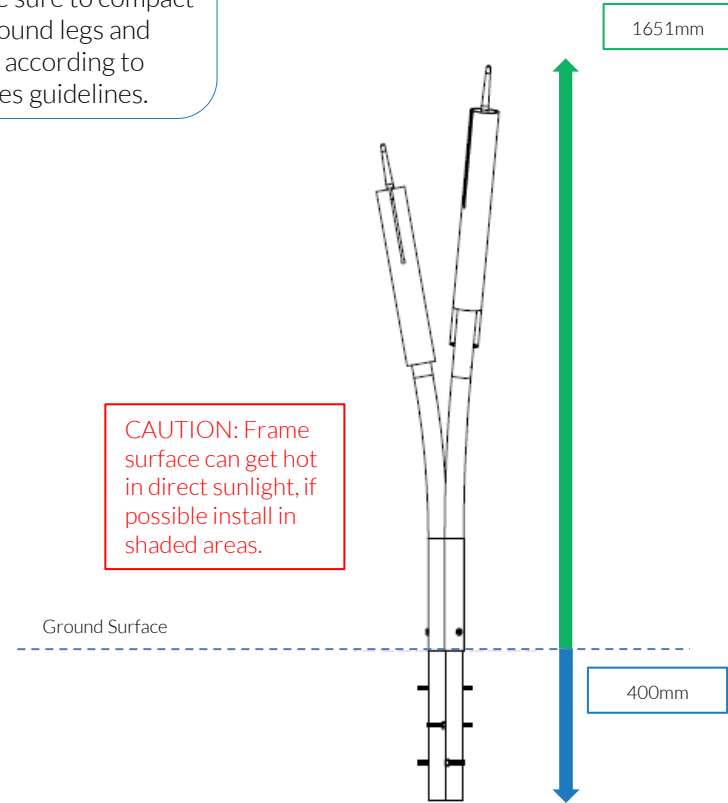

Small Beaters X2

Ground Fix Components:



Spares available from percussionplay.com or from your local distributor

16 Kg

Tools:
 x1
 TX 45 Driver Bit

Ground Fixed

Cattail (3)
 Page 2 of 3

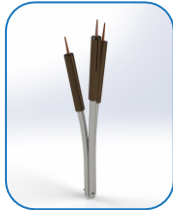

Components:

 x3
 M10x20mm Pin Torx

1.

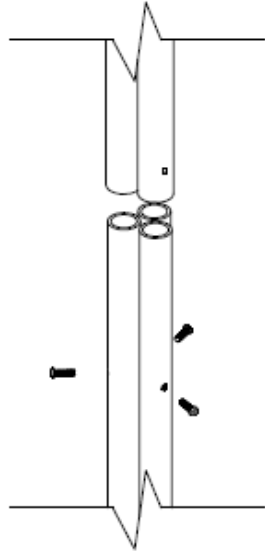

2.

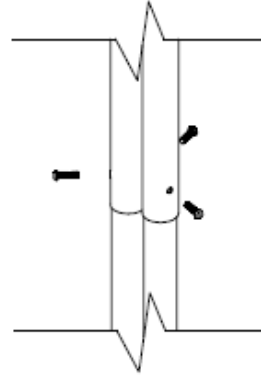

3.

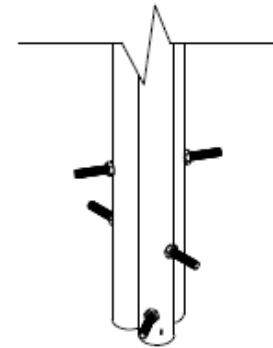
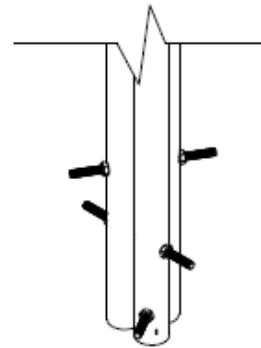
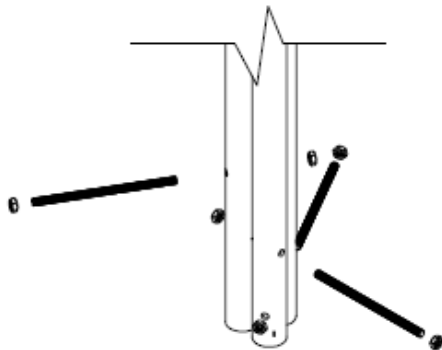
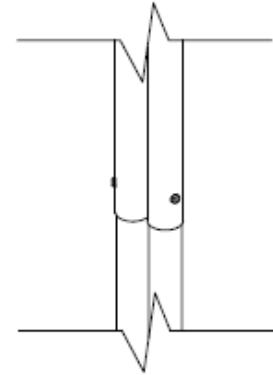

Small
 Beaters X2

Ground Fix
 Components:

 x3
 M10x200 Threaded bar

 x6
 M10 Nut



Spares available from
percussionplay.com or from your
 local distributor

16 Kg

Ground Fix Installation

1. Excavate a hole with a 250mm diameter tapering down to 350mm diameter and 450mm depth.

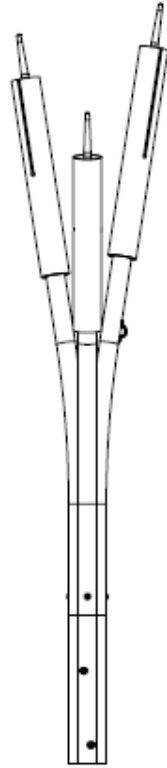

2. Compact base of hole with 50mm of aggregate. Lower ground fix cluster attached to instrument into hole (check instrument straight and level before filling with concrete), ensuring 50mm of clearance between the ground and the bolt & barrel nut holes.

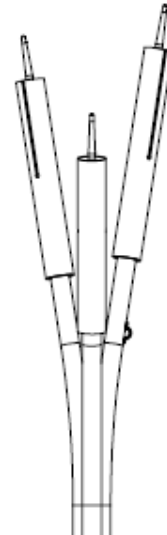

3. Fill hole with fast drying concrete to manufacturers specifications.

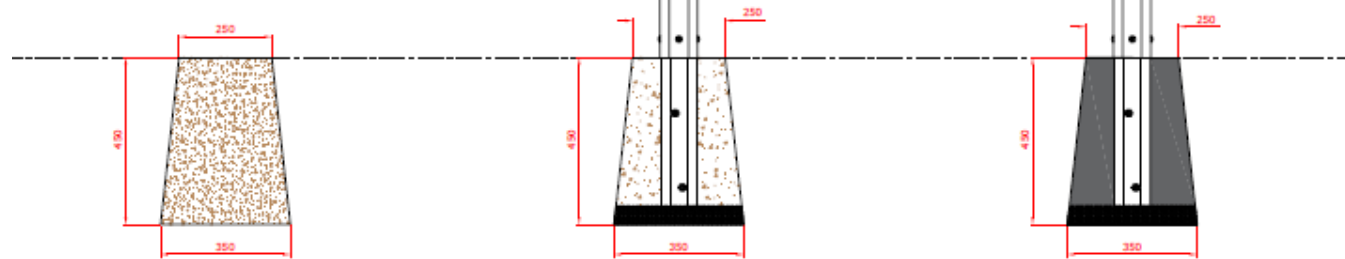
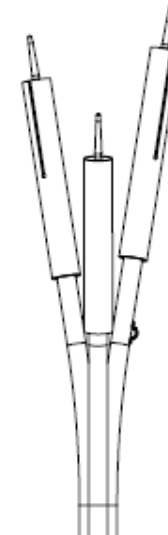

Foundations should not present a hazard. These foundations are recommended as a guide, for more information on foundation details for various surface see Part 1 of BS EN 1176.



Ground Fixed

Cattail (3)
Page 3 of 3

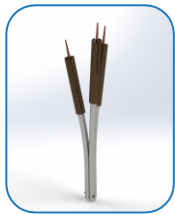

Components:



x3

M10x200 Threaded Bar



x6

M10 Nut

Metric Conversion:
50mm/ 2"
250mm/ 10"
400mm/ 16"
450mm/ 18"



MADE IN BRITAIN
BS EN 1176